

---

# USER GUIDE

---

Hanging Mirrored Jewelry Cabinet with LED  
Model: NT-HF006



[www.nicetree.co](http://www.nicetree.co)

**NORTH AMERICA**

E-mail: [Service@nicetree.co](mailto:Service@nicetree.co)

Address: 505, Bldg 6, Shenglong Garden phase 2,  
No.2 Shenglong Rd., Longcheng  
St., Longgang Dist., Shenzhen

**MANUFACTURER**

Shenzhen Xiaojia Technology Co.Ltd

MADE IN CHINA

02-20-2020  
NT-HF006\_V1.1\_EN

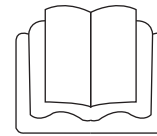

Thank you for purchasing the Nicetree Jewelry Cabinet. Please read this user manual carefully and keep it in a safe place for future reference. If you need any assistance, please contact our support team with your product model number and Amazon order number.





## CONTENTS

<b>Package Contents</b> .....	01
<b>IMPORTANT</b> .....	02
<b>Warning</b> .....	02
<b>Installation</b> .....	04
Door Mount .....	04
Wall Mount .....	06
<b>LED Battery Replacement</b> .....	09
<b>Internal Structure</b> .....	10
<b>Specifications</b> .....	11
<b>Warranty &amp; Customer Support</b> .....	11



## Package Contents

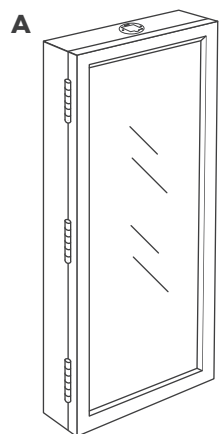

**A**  
Jewelry Cabinet  
1 pc

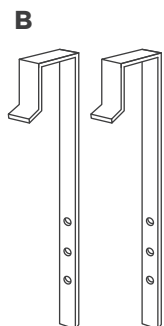

**B**  
Hanging Hooks  
2 pcs

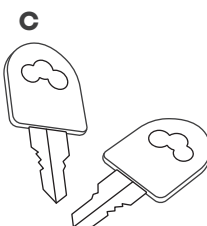

**C**  
Keys  
2 pcs

**Note:**  
You need to purchase 3 AAA batteries for LEDs in the cabinet.

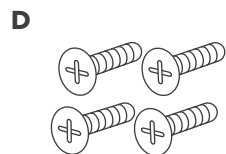

**D**  
Screws  
4 pcs



**E**  
Screw Anchors  
2 pcs

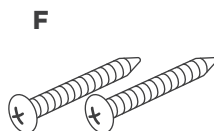

**F**  
Screws  
2 pcs

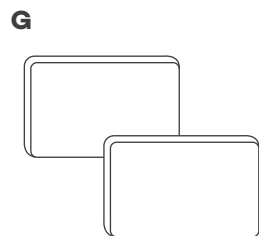

**G**  
Double-sided Tape  
2 pcs



User Guide

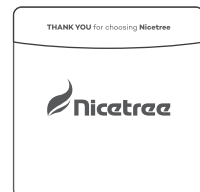

Warranty Card

## IMPORTANT

Please read the following instruction carefully and use the product accordingly. Please keep this manual and hand it over if you transfer the product. This summary may not include every detail of all variations and considered steps. Please contact us when further information and help are needed.

### Warnings

1. The product's primary use is as a mirror and storage cabinet. The user must strictly assemble and use the product in accordance with this manual. The seller does not assume any responsibility or liability with respect to any damage caused by incorrect assembly or improper use.
2. Please check that the cabinet body is intact and that accessories are complete before mounting. Do not place the edge of the unwrapped cabinet on the floor to avoid fraying or damage.
3. When mounting the wall cabinet, please keep the holes away from electrical wires or water pipes, in order to prevent unexpected damage or losses.
4. Follow the assembly steps shown in the diagram to position and adjust the parts, then gradually tighten all screws. Do not tighten excessively.
5. The wall-mounted cabinet comes with screws and bolts, which is suitable for being mounted on solid and flat wall surfaces. Considering the diversity of walls, you need to purchase the appropriate fittings from professional dealers. The tools are not supplied.
6. It is recommended that two adults mount the cabinet together. Take care to mount the cabinet horizontally and ensure it is firmly on the wall to avoid overturning or falling.

7. Open and close the door gently for long-lasting use of the hinges (the widest angle of the door is about 100 degrees).
8. Please put the article on the flat ground and away from sharp and hard objects. Do not drag the cabinet across the floor - please lift it up to move.
9. For daily care, please clean with a soft and dry cloth. If necessary, you can use neutral detergent. Do not wipe the surface with a wet cloth or hard objects.
10. Keep the article away from acidic chemicals, so as not to cause a chemical reaction or discoloration, etc.
11. Keep this product in room with normal temperature. Avoid direct sunlight and do not place next to heat sources, which can cause the deformation, distortion, and even cracking.
12. There may be a smell when the packaging is removed. If so, please place the cabinet in a ventilated area and open the door to remove the smell.
13. The product is not intended for children. Children must be under adult supervision to use the product. Otherwise the seller is not liable for the damage or the injury.
14. Never allow children to climb or play around with the product, in order to protect children from personal injury and to prevent the product falling and the mirror body being broken.
15. The wall model must be mounted on the wall with supplied or self-purchased accessories. Prohibit children from climbing or hanging on the furniture.
16. During the mounting process, keep small objects out of the reach of children. It may be fatal if parts are swallowed or inhaled.
17. To avoid danger of suffocation, keep the plastic bag away from babies and children.

## Installation

### Door Mount

The hooks included fit doors less than 4.5cm thick.

**Step 1:** Install the two hanging hooks on the back of cabinet with the 4 D Screws.

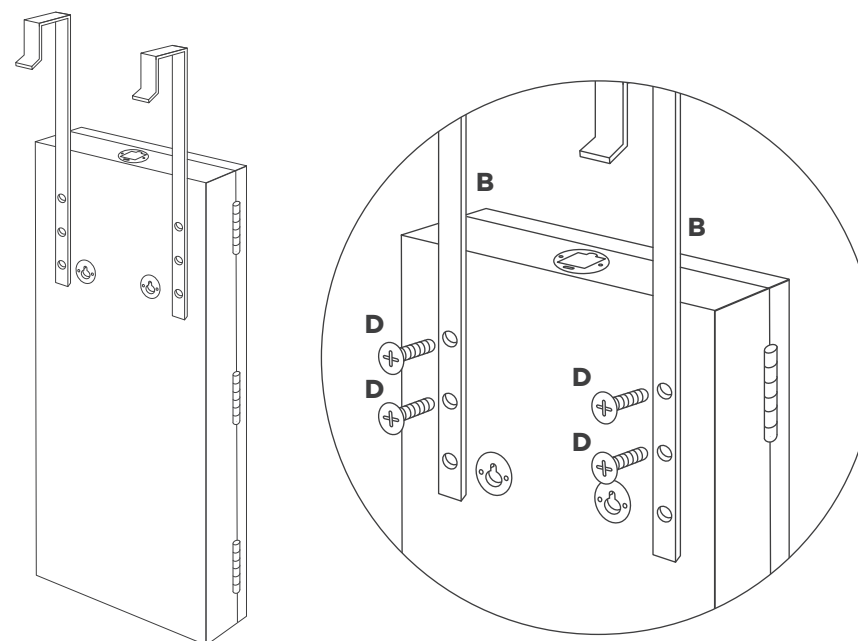

**Step 2:** Attach the two double-sided tapes to the lower part of the back to keep the cabinet from swinging.

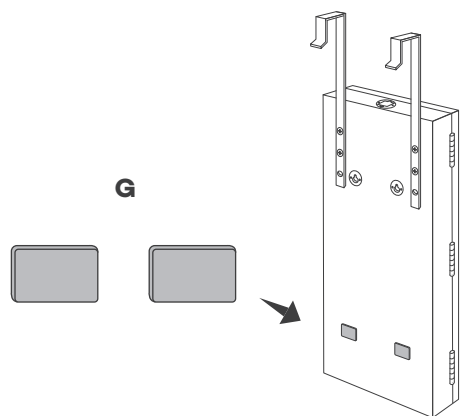

**Step 3:** Hang the cabinet over the door and press it towards the door to fix. Now you can use the keys to lock or open the door.

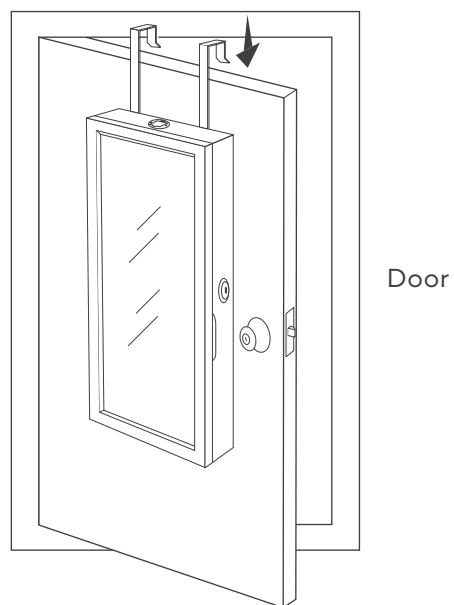

## Installation

### Wall Mount

**Step 1:** Measure and mark the cabinet's position on the wall, then drill the holes.

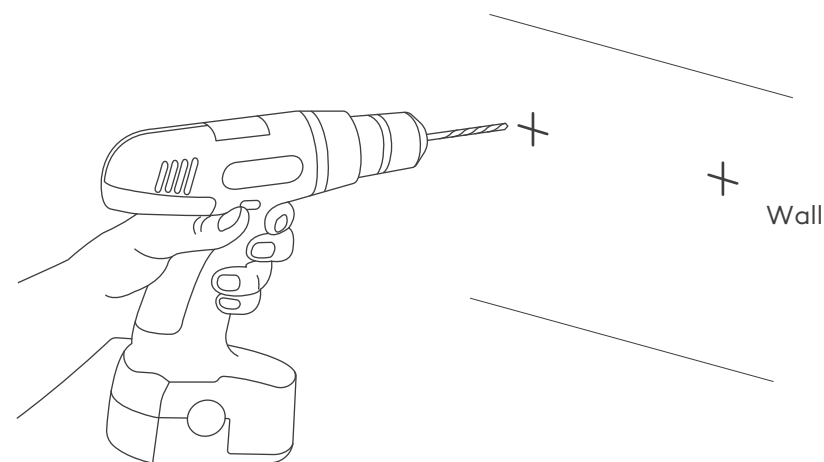
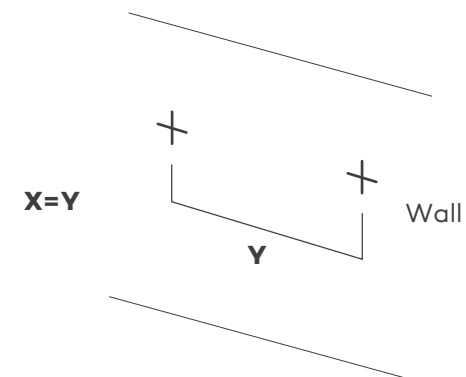
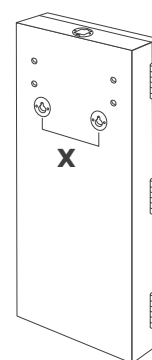

**Step 2:** Insert the E Screw Anchors and F Screws.

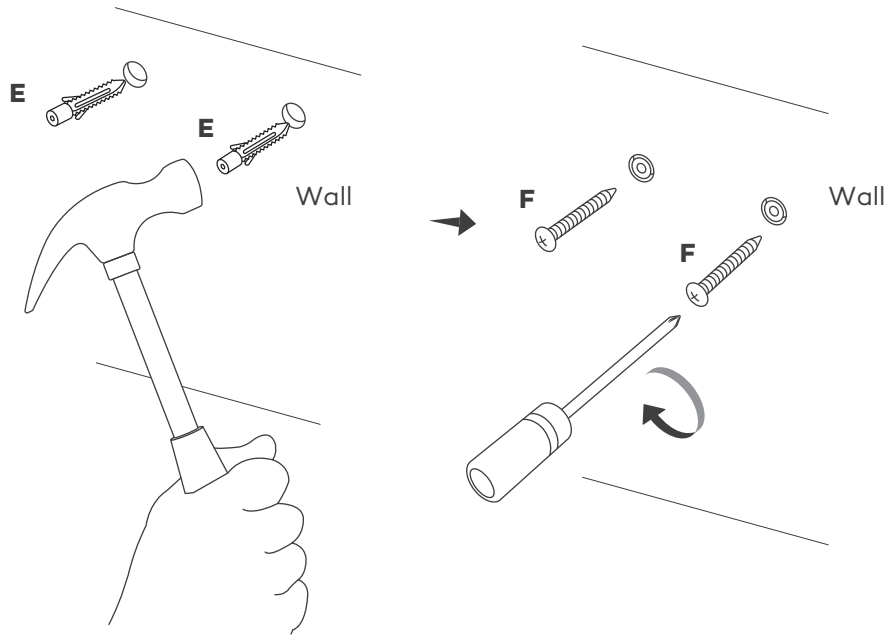

**Step 3:** Attach the two double-sided tapes to the lower part of the back to keep the cabinet from swinging.

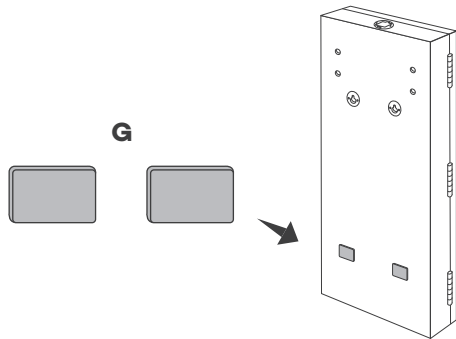

**Step 4:** Hang the cabinet with the F screws and press it towards the wall to fix.

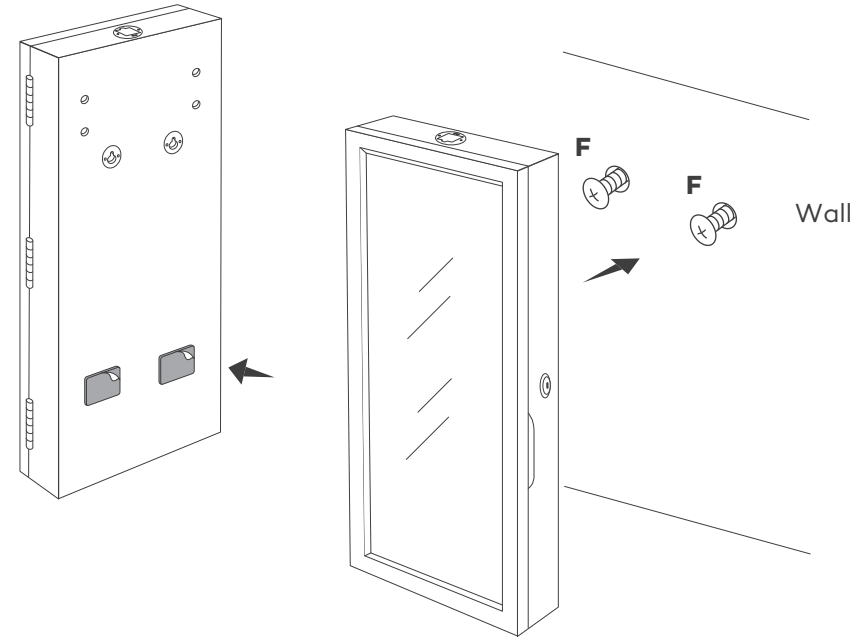

**Note:**

1. Do not place the product in damp areas.
2. Keep accessories away from children during the installation.

## LED Battery Replacement

6 LEDs were installed at the top of the inside of the cabinet during manufacturing. They are powered by 3 AAA batteries and will light up automatically when the door is opened.

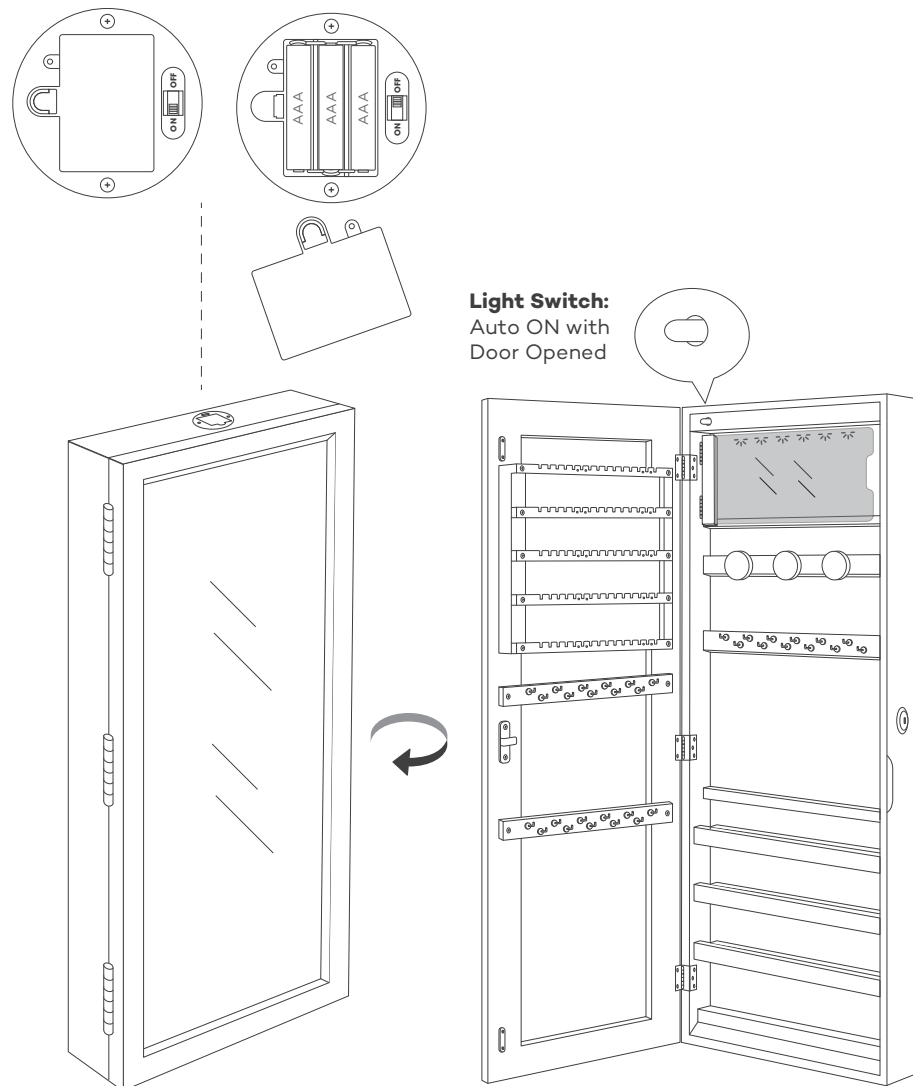

## Internal Structure

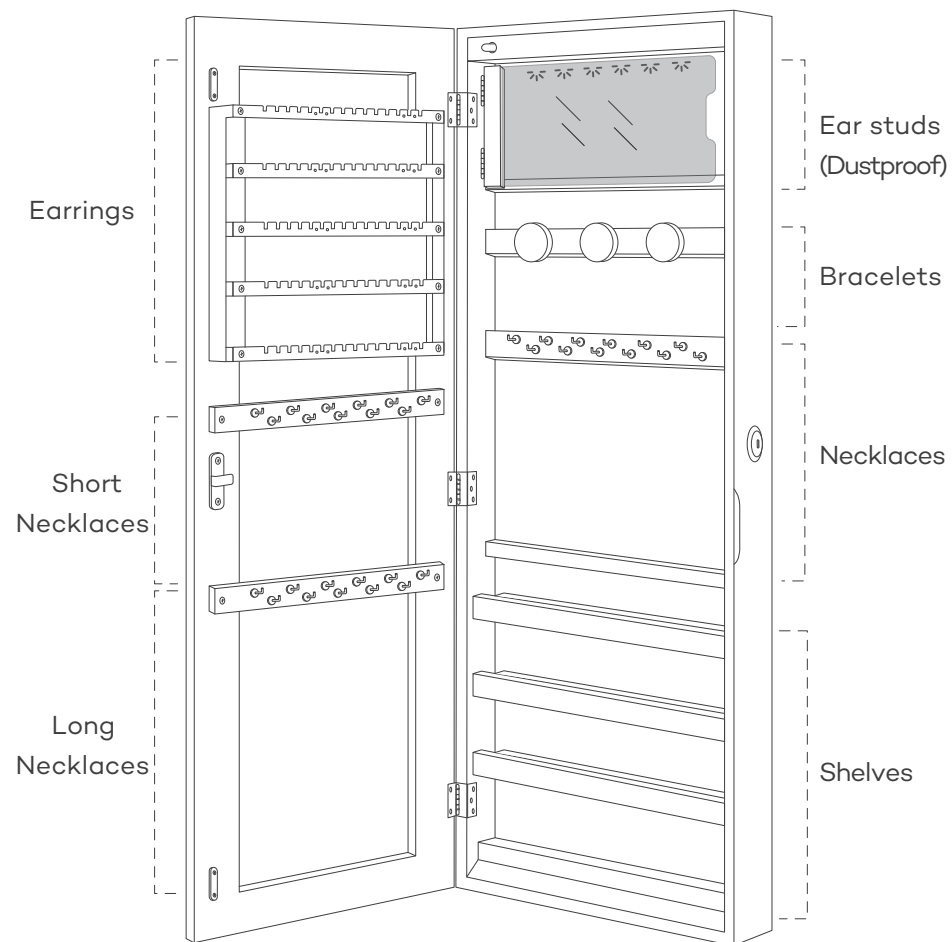





## Specifications

---

Material	Real glass, Quality MDF, Soft Velvet
Mirror Included ?	Yes
LED Included?	Yes
Dimensions	108 x 36.7 x 10.6cm / 42.5 x 14.4 x 4.2in
Weight	10kg / 22lbs

## Warranty & Customer Support

---

### **12 months warranty**

If you need any assistance or have any questions, please contact our store and we will reply within 24 hours. Please leave your order number and details of your question, so we can help you solve the issue as soon as possible.